



EEI
≤ 0.19



WITA go.max 40 | 60



Product advantages

- 5 years warranty
- SmartAdapt function
- LED display of energy consumption
- Night setback mode in minimum speed level
- Button lock
- Anti-block function

Technical data

| 40 | 60

Art. no.
page: 87

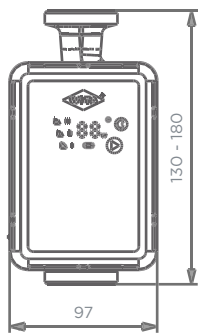

G 1"; G 1½"; G 2"

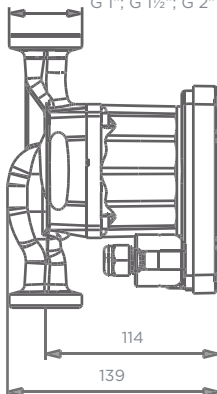

Maximum delivery head	4 m 6 m
Maximum flow rate	2600 l/h 3400 l/h
Power consumption	3-23 W 4-43 W
Regulation	3 constant speed modes, 3 constant pressure characteristics, 3 proportional pressure modes
Additional function	Smart Adapt, automatic night mode
Supply voltage	1 x 230 V 50 Hz
Motor protection	no external motor protection required
Emission sound pressure level	< 43 dB(A)
Protection rating	IP44
Ambient temperature	0 °C to 40 °C
Media temperature	2 °C to 95 °C
Temperature class	TF 95
Max. system pressure	10 bar (1 MPa)
Connection sizes	DN 15, DN 25, DN 32
Installation lengths	130 mm, 180 mm
Permitted pumped media	heating water according to VDI 2035 water/glycol mixture 1:1
Weight incl. insulation	2.4 kg
EEI	≤ 0.19

All product dimensions are presented in mm.

Characteristic WITA go.max 40-XX

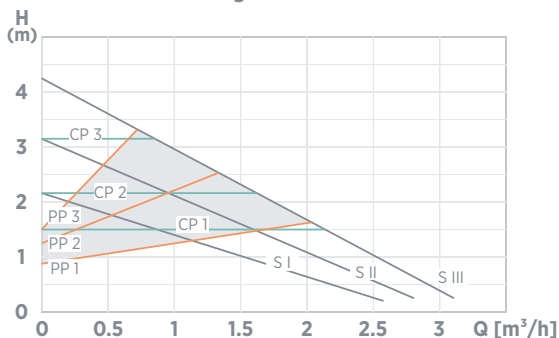

Characteristic WITA go.max 60-XX

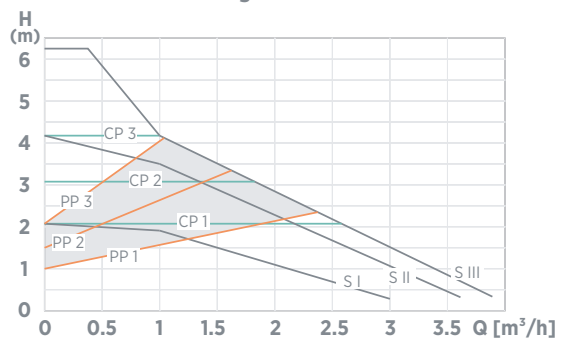



EEL
≤0.23



WITA go.max

80 | 100 | 120



Product advantages

- 5 years warranty
- SmartAdapt function
- LED display of energy consumption
- Automatic night mode
- Anti-block function
- PWM external control for heating and solar available

Technical data

| 80 | 100 | 120 Art. no. page: 87

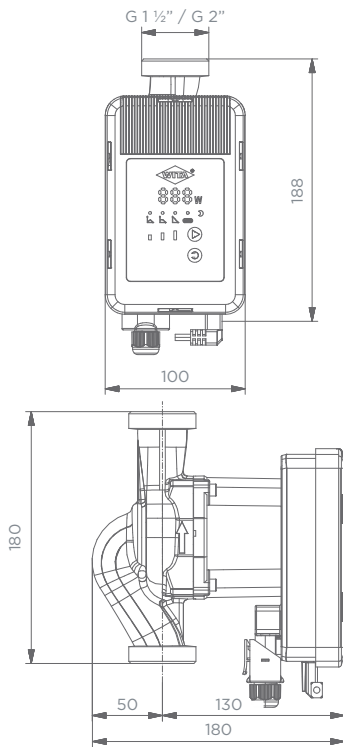

All product dimensions are presented in mm.

Maximum delivery head	8 m 10 m 12 m
Maximum flow rate	6 600 l/h 7 600 l/h 8 600 l/h
Power consumption	80 W 120 W 180 W
Regulation	3 constant speed modes, 3 constant pressure characteristics, 3 proportional pressure modes,
Additional function	Smart Adapt, automatic night mode
Supply voltage	1 x 230 V, 50 Hz
Motor protection	no external motor protection required
Protection rating	IP44
Ambient temperature	0 °C to 40 °C
Media temperature	2 °C to 110 °C
Temperature class	TF 110 according to EN 60335-2-51
Max. system pressure	1.0 MPa 10 bar
Connection sizes	DN 25, DN 32
Installation lengths	180 mm
Pump housing material	grey cast iron cataphoretic coated
Weight incl. insulation	3.1 kg
EEL	≤ 0.23
Additional options	also available as PWM version

Characteristic WITA go.max 80-XX

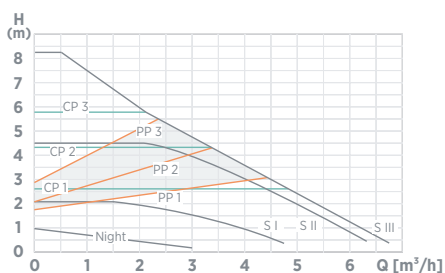

Characteristic WITA go.max 100-XX

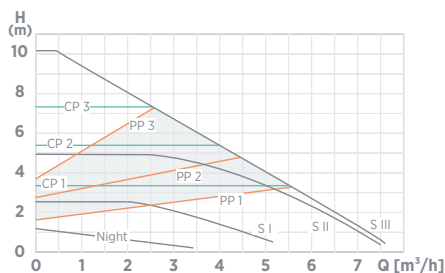

Characteristic WITA go.max 120-XX

